

PWC KIT - X-Paket und Skimodul

Produkt:	Sea-Doo_watercraft
Projekt Nein:	487800677_rev2
Anleitung P/N:	487800677
Überarbeitung Nr:	2
Änderungsdatum:	Oktober 2017
Abgedeckter Artikel:	X-Paket und Skimodul

Die folgenden Symbole können in diesem Dokument verwendet werden:

WARNUNG

Weist auf eine gefährliche Situation hin, die zum Tod oder zu schweren Verletzungen führen kann, wenn sie nicht vermieden wird.

 **VORSICHT:** Weist auf eine Gefahrensituation hin, die, wenn sie nicht vermieden wird, zu leichten oder mittelschweren Verletzungen führen kann.

HINWEIS Weist auf eine Anweisung hin, deren Nichtbeachtung zu schweren Schäden an Fahrzeugkomponenten oder anderem Eigentum führen kann.

WARNUNG

- Aus Sicherheitsgründen muss dieses Kit von einem autorisierten BRP-Händler installiert werden.
- Dieses Kit ist nur für bestimmte zutreffende Modelle ausgelegt (autorisierte BRP-Händler bestätigen die Modelle). Es wird nicht für andere Geräte als das (die) empfohlen, für die es verkauft wurde.
- Wenn für die Installation des Kits eine Schablone erforderlich ist, stellen Sie sicher, dass die Schablone maßstabsgetreu ist.
- Sollte bei der Demontage/Montage das Entfernen einer Verriegelung (z. B. Sicherungsglaschen, selbstsichernde Verschlüsse etc.) erforderlich sein, immer durch eine neue ersetzen.
- Die Anzugsvorgaben für Drehmomentschlüssel müssen unbedingt eingehalten werden.
- Tragen Sie immer einen AUGENSCHUTZ UND GEEIGNETE HANDSCHUHE, wenn Sie Elektrowerkzeuge verwenden.
- Sofern nicht anders angegeben, muss der Motor bei allen Arbeiten am Fahrzeug ausgeschaltet sein.
- Achten Sie immer auf Teile, die sich bewegen können, wie Räder, Getriebekomponenten usw.
- Einige Komponenten können HEISS sein. Warten Sie immer, bis der Motor abgekühlt ist, bevor Sie Arbeiten ausführen.

WARNUNG

Einige wichtige Sicherheitsinformationen und/oder Betriebsanweisungen für den Endverbraucher können in diesem Anweisungsblatt enthalten sein. Stellen Sie sicher, dass Sie dem Kunden die Kit-Teilenummer sowie das diesem Kit beiliegende Anleitungsblatt mitteilen. Stellen Sie sicher, dass der Kunde Zugriff auf alle Informationen hat, die für die ordnungsgemäße Verwendung des Zubehörs erforderlich sind.

HINWEIS : VERWENDEN SIE DIE ANZUGSDREHMOMENTE IN DER FOLGENDEN TABELLE, WENN NICHT ANDERS ANGEGEBEN.

	GRAD			
	5.8	8.8	10.9	12.9
M4	1,8 ± 0,2 N•m (16 ± 2 lbf• Zoll)	2,8 ± 0,2 N•m (25 ± 2 lbf• Zoll)	3,8 ± 0,2 N•m (34 ± 2 lbf• Zoll)	4,5 ± 0,5 N•m (40 ± 4 lbf• Zoll)
M5	3,3 ± 0,2 N•m (29 ± 2 lbf• Zoll)	5 ± 0,5 N•m (44 ± 4 lbf• Zoll)	7,8 ± 0,7 N•m (69 ± 6 lbf• Zoll)	9 ± 1 N•m (80 ± 9 lbf• Zoll)
M6	7,5 ± 1 N•m (66 ± 9 lbf• Zoll)	10 ± 2 N•m (89 ± 18 lbf• Zoll)	12,8 ± 2,2 N•m (113 ± 19 lbf• Zoll)	16 ± 2 N•m (142 ± 18 lbf• Zoll)
M8	15,3 ± 1,7 N•m (135 ± 15 lbf• Zoll)	24,5 ± 3,5 N•m (18 ± 3 lbf•ft)	31,5 ± 3,5 N•m (23 ± 3 lbf•ft)	40 ± 5 N•m (30 ± 4 lbf•ft)

M10	29 ± 3 N•m (21 ± 2 lbf•ft)	48 ± 6 N•m (35 ± 4 lbf•ft)	61 ± 9 N•m (45 ± 7 lbf•ft)	73 ± 7 N•m (54 ± 5 lbf•ft)
M12	52 ± 6 N•m (38 ± 4 lbf•ft)	85 ± 10 N•m (63 ± 7 lbf•ft)	105 ± 15 N•m (77 ± 11 lbf•ft)	128 ± 17 N•m (94 ± 13 lbf•ft)
M14	85 ± 10 N•m (63 ± 7 lbf•ft)	135 ± 15 Nm (100 ± 11 lbf•ft)	170 ± 20 N•m (125 ± 15 lbf•ft)	200 ± 25 N•m (148 ± 18 lbf•ft)
M16	126 ± 14 N•m (93 ± 10 lbf•ft)	205 ± 25 N•m (151 ± 18 lbf•ft)	255 ± 30 N•m (188 ± 22 lbf•ft)	305 ± 35 N•m (225 ± 26 lbf•ft)
M18	170 ± 20 N•m (125 ± 15 lbf•ft)	273 ± 32 N•m (201 ± 24 lbf•ft)	330 ± 25 N•m (243 ± 18 lbf•ft)	413 ± 47 N•m (305 ± 35 lbf•ft)

NOTE: The illustrations in this document show typical construction of the different assemblies and may not reproduce the full detail or exact shape of the parts; however, they represent parts that have the same or similar function.

NOTE: Installation time is approximately 0.5 hour.

Parts to be installed

ITEM	DESCRIPTION	PART NUMBER	QTY	
			X-Package Kit	Ski Module Kit
P1	X-Package Module	Not Available Separately	0	1
P6	Ski Module	Not Available Separately	1	0
P2	Fuse (3 amp)	710001008		1
P3	Module Harness	Not Available Separately		1
P4	Locking Tie 368 mm (14.5 in)	293750008		1
P5	Locking Tie 188 mm (7.4 in)	414115200		4

Instructions

Module Installation

Access to battery

For GTI and GTS models

For 2017 and up GTI and GTS 900, go directly to step 18.

1. Open front storage compartment.
2. Remove battery access panel
 - 2.1 Remove both plastic fasteners and rubber tie.
 - 2.2 Free panel from notches at the bottom by pulling it upwards.



1. Battery access panel
- 2.3 Disassemble and remove both panels halves from compartment.

For GTX and RXT platforms 2018+

1. Remove the passenger's and the driver's seats.

For GTX and RXT platforms with suspension

1. Open the aft re-boarding platform.

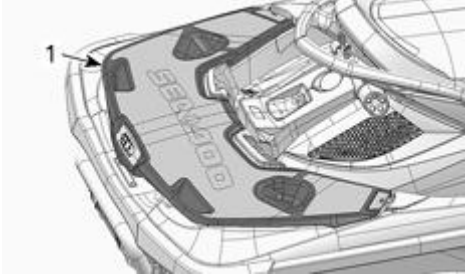

1. Re-boarding platform
2. Remove the starboard storage bin.



1. Starboard storage bin
- GTX and RXT platforms without suspension

3. Open starboard access cover.

Electrical Connection (All platforms except GTX and RXT MY2018+)

1. Disconnect BLACK (-) battery cable then the RED (+) cable.



WARNING

Always disconnect battery cables exactly in the specified order.

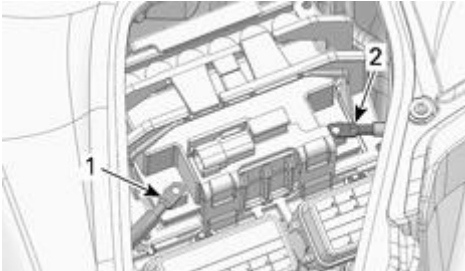

1. BLACK (-) cable

2. RED (+) cable

2. Lift and push the top of electrical component support to unlock it from battery holder. Move support aside to make room.

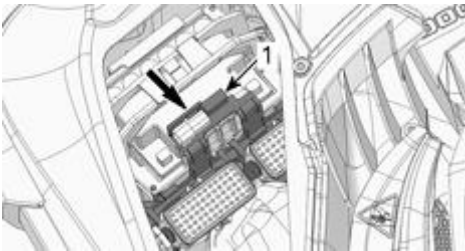

typical

1. Electrical component support

3. Unplug the diagnostic connector.

4. Install wire terminal from module harness [P3] in diagnostics connector pin 6.

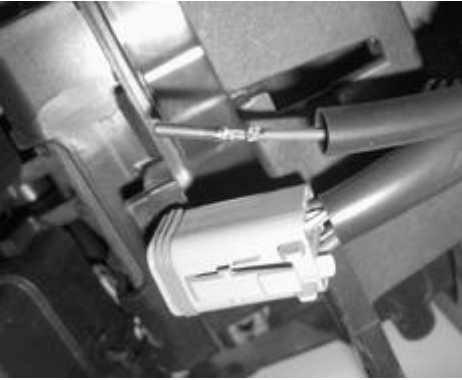

4.1 Pull diagnostic connector cap from its socket.



1. Diagnostic connector socket
2. Diagnostic connector cap

4.2 Remove the plastic plug from the socket diagnostic pin hole no. 6.



4.3 Insert and lock the wire terminal from harness [P3] into its location.
NOTE: A "click" is heard as the terminal is locking.

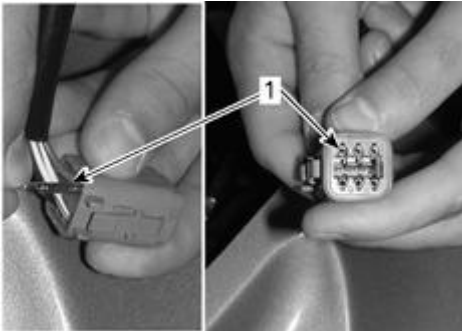

1. Terminal connection for diagnostic pin no. 6

4.4 Adjust the seal band around the socket end.

4.5 Push the connector cap in the socket until it clicks.

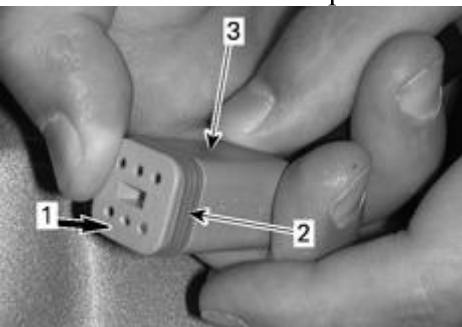

1. Diagnostic connector cap
2. Seal band
3. Diagnostic connector socket

5. Route module harness [P3] to fuse box along diagnostic harness and secure it with locking ties.
 6. Detach fuse box from the electrical component support.
 7. Move locking tabs aside to unlock the fuse box.
 8. Remove fuse box cover.
 9. Locate the free cavities (D11, E11 and F11) to connect new wires.
- NOTE: Cavities are identified at the back of the fuse box. Pay attention to the cavity numbers as the rows don't all have 12 cavities.

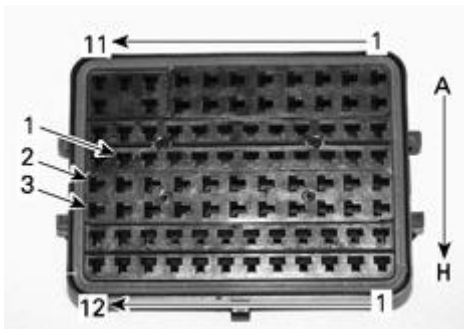

Top view - Rows from A to H and columns from 1 to 12

1. D11 location
2. E11 location
3. F11 location

30A RELAY		1. 5A 5A CTRL	2. 15A DIAG TOOL	3. 3A STANDBY/STOP	4. 3A 5V5	5. 30A 5V5	6. 30A CHARGE	7. 30A FUEL PUMP IS	8. 30A INTT.	
+12 VOLTS ACCESSORY		+12 VOLTS				+12 VOLTS				
+12 VOLTS ACCESSORY										
9.	10.	11. 3A 5V5	12. 3A 5V5	13. 10A 5V5	14. 10A 5V5	15. 10A 5V5	16. 5A 5V5	17. 5A 5V5	18. 10A FUEL PUMP	19. 15A 5V5
COMMUNICATION (CAN HI)					COMMUNICATION (CAN LOW)					
+12 VOLTS ACCESSORY		GROUND								

10. Using a small tool, pull out the seal plugs from the related cavities (described previously) at the back of fuse box.



1. Seal out of its cavity - TYPICAL
11. Remove bus bar from D-Row

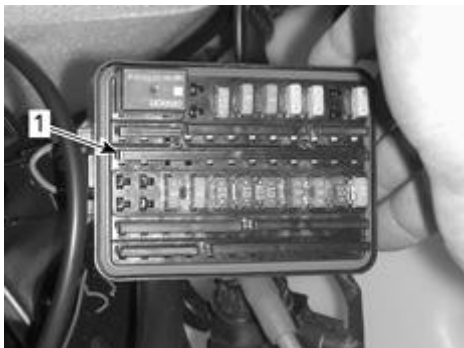

d-row (12-pins) bus bar shown

NOTICE Carefully remove bus bar by simultaneously pulling on both sides of bus bar during removal.

12. Insert wire terminals in their proper cavities and lock.

Action	Default routing cavity no	wire identification
Install	D11	Red/ Purple
Install	E11	Red/ Purple

Action**Default routing cavity no****wire identification**

Install

F11

Violet

NOTE: Terminal cavities have different orientations depending on their position in the fuse box. When inserting the terminals in their respective cavities, make sure to follow the orientation of the cavity. When the terminals are inserted correctly into their cavities, they will "click-in". Verify that the terminals are properly locked in their cavities by pulling back on the wire to be sure the retaining clips are holding to terminal.

13. Reinstall removed bus bar in D-Row.

14. Install new 3A fuse [P2] in fuse box in cavity E11/F11.

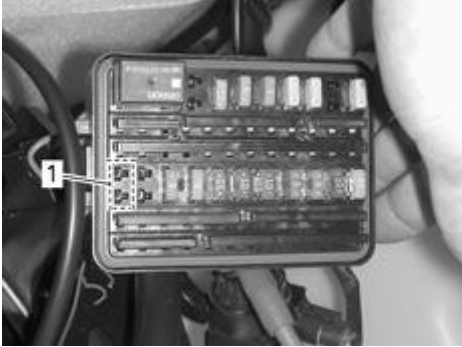

1. 3A fuse [P2] installation location

15. Install the fuse box and its cover.

16. Reinstall electrical component support.

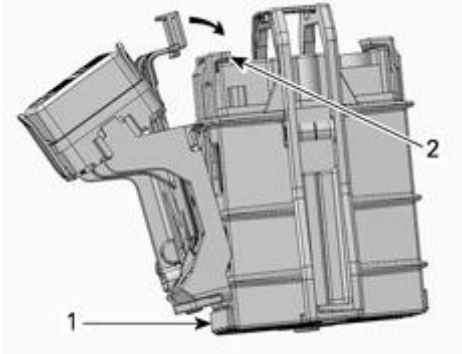

1. Lower receptacle

2. Upper retaining tab

16.1 Insert lower tabs from component support into lower receptacle.

16.2 Push component support onto upper retaining tab.



17. Apply small amount of DIELECTRIC GREASE (P/N 293 550 004) to vehicle diagnostic connector.

18. Couple the vehicle diagnostic connector to the module connector (input).

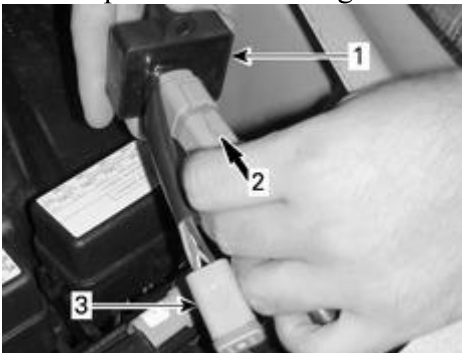

1. Module [P1]

2. Vehicle diagnostic connector

3. Module connector (accessory)

19. Secure module to the battery support with locking tie [P4].

NOTICE Make sure that module is attached firmly and cannot move around.

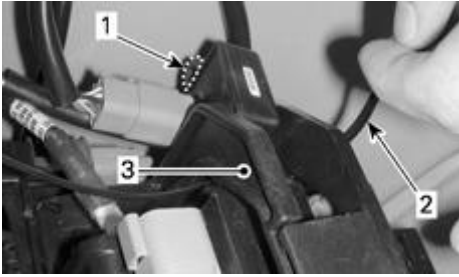

1. Module attachment points
2. Locking tie [P4]
3. Battery support

20. Apply small amount of DIELECTRIC GREASE (P/N 293 550 004) to module diagnostic connector.
21. Connect module diagnostic connector to the vehicle connector.

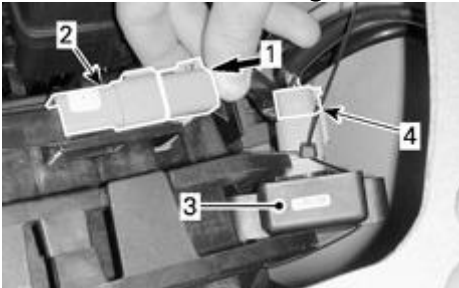

1. Module diagnostic connector
2. Vehicle connector
3. Module [P1] secured to support
4. Vehicle diagnostic connector

NOTE: The module diagnostic connector can now be used instead of the standard connector for vehicle diagnostics.

22. Connect RED (+) battery cable then the BLACK (-) cable.



WARNING

Always connect battery cables exactly in the specified order.

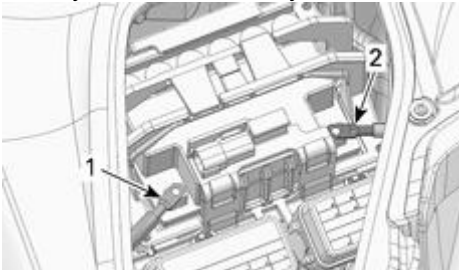

1. BLACK (-) cable
2. RED (+) cable

23. Firmly insert tether cord cap on engine cut-off switch.

24. Check information center to confirm the new features are available from the menu.

NOTE: Refer to the OPERATOR'S GUIDE for instructions of how to use the new features.

25. Reinstall all other removed parts.

Electrical Connection (for GTX and RXT platforms MY2018+)

1. Unplug the diagnostic connector.
2. Pull diagnostic connector cap from it's socket.



1. Diagnostic connector cap
3. Fix the module to the air intake rubber tube using a locking tie 368 mm (14.5 in)[P4]. The locking tie should be between two ribs on the intake tube.



1. X-Package module [P1]
 2. Locking tie 368 mm (14.5 in)[P4]
 3. Position between the two ribs
 4. Air intake tube
4. Pass the diagnostic connector cable above the coolant hose and connect into the module. Fix the diagnostic connector cable using a locking tie 188 mm (7.4 in)[P5].



1. Diagnostic connector cable
2. Locking tie 188 mm (7.4 in)[P5]
3. Coolant hose

NOTICE Make sure the diagnostic connector cable **DOES NOT** touch the engine.

Multiple Modules Installation

According to specific accessories installed, modules can be plugged in series to combine additional features.

1. Install additional modules by attaching them to the battery support with locking ties provided.
2. Tragen Sie vor dem Anschluss eine kleine Menge DIELECTRIC GREASE (P/N 293 550 004) auf die Modulanschlüsse auf.

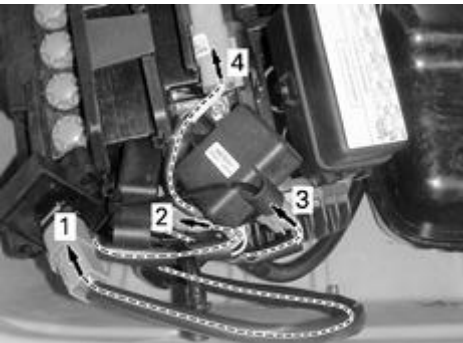

1. Ausgang des Fahrzeugdiagnosesteckers zu Modul 1
2. Modulstecker 1 an Modul 2
3. Modulstecker 2 an Modul 3
4. Modulstecker 3 zum Eingang des Fahrzeugsteckers

HINWEIS Stellen Sie sicher, dass alle Module fest angebracht sind, um eine Beschädigung während des Betriebs des Fahrzeugs zu vermeiden. Drücken Sie auch nicht auf das Batterieentlüftungsrohr in der Nähe.